

HO  
RE  
CA

**abert**









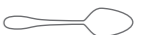

Novità/Novelties

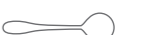
2025



# Salina

Inox 18/10 - St. Steel - 3 mm  
Cod. CBS..

COD. CBS..		L. mm
01		206
02		208
03		175
05		235
11		185
12		186
15		211
21		137
22		113
38		146

**Coltello carne Mukaku manico POM avorio**

Mukaku meat knife, POM ivory handle  
 Couteau à viande Mukaku, manche en POM ivoire  
 Mukaku Fleischmesser, POM Elfenbeergriff  
 Cuchillo de carne Mukaku, mango de POM marfil

**Acciaio Inox - St. Steel / POM**

	mm	in
CPE55	222	87,4

**Coltello carne Asado manico legno**

Asado meat knife, wooden handle  
 Couteau à viande Asado, manche en bois  
 Asado Fleischmesser, Holzgriff  
 Cuchillo de carne Asado, mango de madera

**Acciaio Inox - St. Steel**

	mm	in
CPD55	225	88,58

**Coltello carne Lomo manico POM nero sat.**

Lomo meat knife, satin black POM handle  
 Couteau à viande Lomo, manche POM noir satiné  
 Lomo Fleischmesser, satiniert schwarzer POM-Griff  
 Cuchillo de carne Lomo, mango POM negro satinado

**Acciaio Inox - St. Steel / POM**

	mm	in
CPF55	218,4	85,98

**Coltello carne forg. Ozaki manico POM nero sat.**

Ozaki forged meat knife, satin black POM handle  
 Couteau à viande forgé Ozaki, manche POM noir satiné  
 Ozaki geschmiedetes Fleischmesser, satiniert schwarzer POM-Gri  
 Cuchillo de carne forjado Ozaki, mango POM negro satinado

**Acciaio Inox - St. Steel / POM**

	mm	in
CPH55	230	90,55



**Taglia tartufi, lama seghettata**

Truffle cutter, smooth blade  
 Trancheuse à truffes, lame lisse  
 Cortador de trufas, hoja lisa  
 Trüffelhobel, glatte Klinge

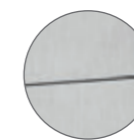

**Acciaio Inox - St. Steel**

	cm	in
903 06 91 001	19,7x8,8	7,76 × 3,46
Lama liscia - Smooth blade		

903 06 91 002	19,7x8,8	7,76 × 3,46
Lama seghettata - Serrated blade		

**Taglia tartufi c/man. noce, lama liscia**

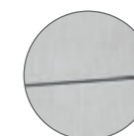
Truffle cutter with walnut handle, smooth blade  
 Trancheuse à truffes avec manche en noyer, lame lisse  
 Cortador de trufas con mango de nogal, hoja lisa  
 Trüffelhobel mit Nussbaumgriff, glatte Klinge

**Acciaio Inox - St. Steel**

	mm	in
903 06 91 003	19,7x8,8	7,76 × 3,46
Lama liscia - Smooth blade		

903 06 91 004	19,7x8,8	7,76 × 3,46
Lama seghettata - Serrated blade		

**Porta tartufo con cloche**

Truffle holder with cloche  
 Porte-truffe avec cloche  
 Trüffelhalter mit Cloche  
 Soporte para trufa con campana

**Vetro - Acciaio - Legno / Glass - St. steel - Wood**

	ø cm	h cm	ø cm	h cm
903 06 91 010	13	18	5,51	7,09



**Poggiaposate chopsticks tube 2 posizioni**

Chopsticks Tube Cutlery Holder – 2 Positions  
 Porte-Couverts Chopsticks Tube – 2 Positions  
 Porta Cubiertos Chopsticks Tube – 2 Posiciones  
 Besteckhalter Chopsticks Tube – 2 Positionen

**Acciaio Inox 18/10 - St. Steel 18/10**

	∅ cm	∅ in	H. cm	H. in
903 05 84 685	2	3/4	5,6	2,1/8

- Rame - Copper** 903 40 84 685
- Oro - Gold** 903 41 84 685
- Nero - Black** 903 42 84 685



**Poggiaposate chopsticks tube 3 posizioni**

Chopsticks Tube Cutlery Holder – 3 Positions  
 Porte-Couverts Chopsticks Tube – 3 Positions  
 Porta Cubiertos Chopsticks Tube – 3 Posiciones  
 Besteckhalter Chopsticks Tube – 3 Positionen

**Acciaio Inox 18/10 - St. Steel 18/10**

	∅ cm	∅ in	H. cm	H. in
903 05 84 686	2	3/4	10,5	4,1/8

- Rame - Copper** 903 40 84 686
- Oro - Gold** 903 41 84 686
- Nero - Black** 903 42 84 686





#### Bacchette sushi Square

Square sushi chopsticks  
 Baguettes à sushi Square  
 Square Sushi stäbchen  
 Palillos para sushi Square

**Acciaio Inox 18/10 - St. Steel 18/10**

	L. mm	ø mm
903 05 84 66 306	230	9

Set 6 pz - 6-pc set

● Oro - Gold 903 41 84 66 306

● Nero - Black 903 42 84 66 306

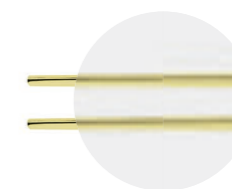

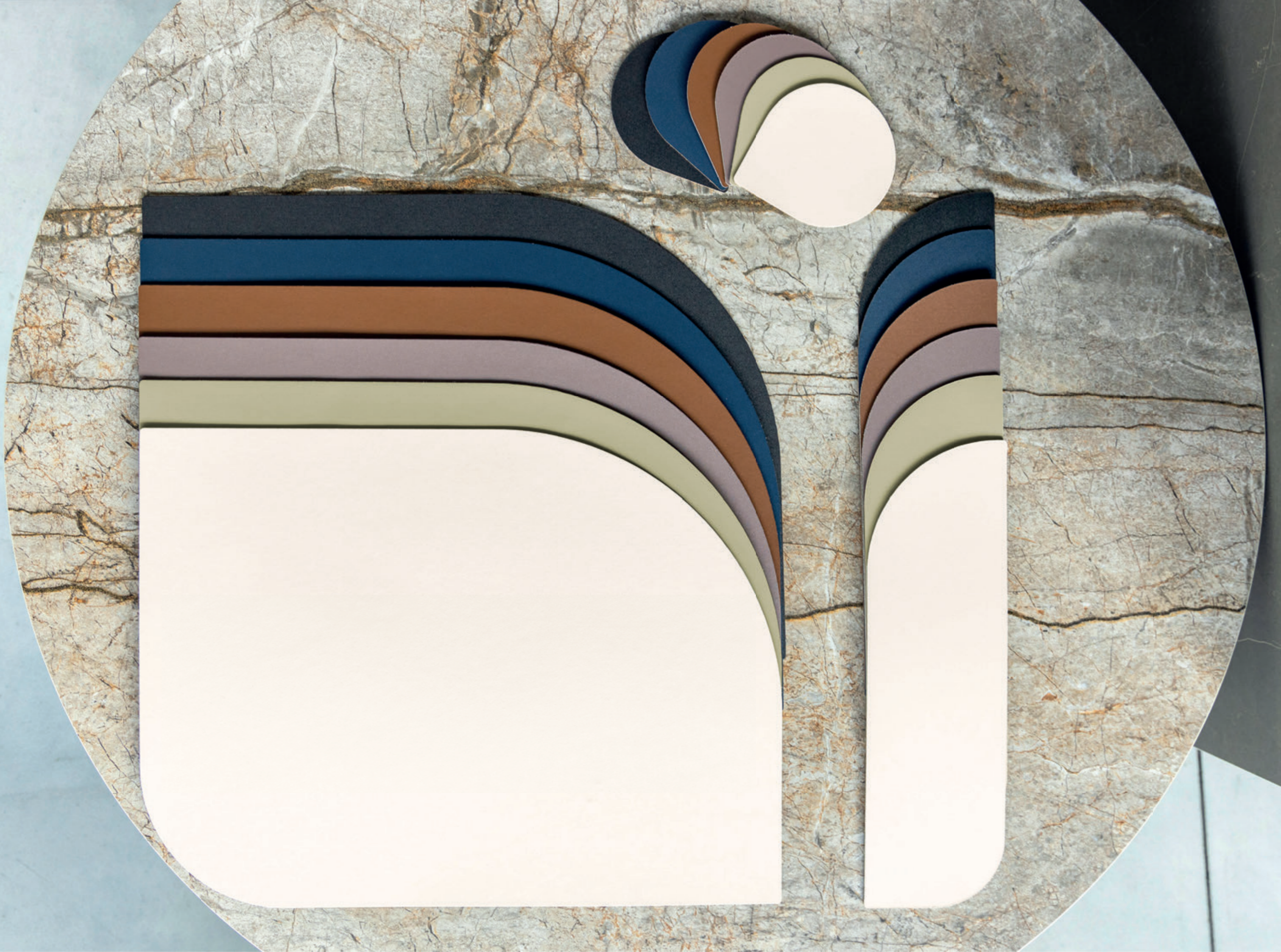

**Tovaglietta Loto - Crema**

Placemat Loto, cream  
Nappe Loto, crème  
Mantel Loto, crema  
Klein Loto, cream

**Pelle riciclata - Recycled leather**

	cm	in
915 01 27 005	40x30	15,75 x 11,81



**Tovaglietta Loto - Verde Salvia**

Placemat Loto, sage green  
Nappe Loto, vert sauge  
Mantel Loto, salvia  
Klein Loto, salbeigrün

**Pelle riciclata - Recycled leather**

	cm	in
915 01 27 003	40x30	15,75 x 11,81



**Tovaglietta Loto - Terra**

Placemat Loto, earth brown  
Nappe Loto, brun terre  
Mantel Loto, marrón tierra  
Klein Loto, erd-braun

**Pelle riciclata - Recycled leather**

	cm	in
915 01 27 004	40x30	15,75 x 11,81



**Tovaglietta Loto - Tortora**

Placemat Loto, taupe  
Nappe Loto, individuelle taupe  
Mantel Loto, individual gris topo  
Klein Loto, tischttuch grau

**Pelle riciclata - Recycled leather**

	cm	in
915 01 27 006	40x30	15,75 x 11,81



**Tovaglietta Loto - Nera**

Placemat Loto, black  
Nappe Loto, noire  
Mantel Loto, negro  
Klein Loto, schwarz

**Pelle riciclata - Recycled leather**

	cm	in
915 01 27 001	40x30	15,75 x 11,81



**Tovaglietta Loto - Blu**

Placemat Loto, blue navy  
Nappe Loto, bleu marine  
Mantel Loto, azul marino  
Klein Loto, marineblau

**Pelle riciclata - Recycled leather**

	cm	in
915 01 27 002	40x30	15,75 x 11,81







**Poggiaposate Loto**

Loto cutlery rest  
 Repose-couverts Loto  
 Reposacubiertos Loto  
 Loto-Besteckhalter

**Pelle riciclata - Recycled leather**

	cm	in
915 10 27 001 - Nero/Tortora	9x30	3,54 x 11,81
915 10 27 002 - Blu/Terra	9x30	3,54 x 11,81
915 10 27 003 - Verde Salvia/Crema	9x30	3,54 x 11,81



**Nero-Tortora**  
 black/taupe

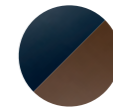

**Blu-Terra**  
 blue navy/earth brown



**Verde Salvia-Crema**  
 sage green/cream

**Poggiabicchieri Loto**

Loto coaster  
 Dessous de verre Loto  
 Posavasos Loto  
 Loto-Untersetzer

**Pelle riciclata - Recycled leather**

	cm	in
915 11 27 001 - Nero/Tortora	9x9	3,54 x 3,54
915 11 27 002 - Blu/Terra	9x9	3,54 x 3,54
915 11 27 003 - Verde Salvia/Crema	9x9	3,54 x 3,54



**Nero-Tortora**  
 black/taupe

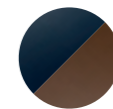

**Blu-Terra**  
 blue navy/earth brown



**Verde Salvia-Crema**  
 sage green/cream

**Tovaglietta Skin - Crema**

Placemat Skin, cream  
 Nappe Skin, crème  
 Mantel Skin, crema  
 Klein Skin, cream

**Pelle riciclata - Recycled leather**

	cm	in
915 02 27 005	42x30	16,5 x 11,8

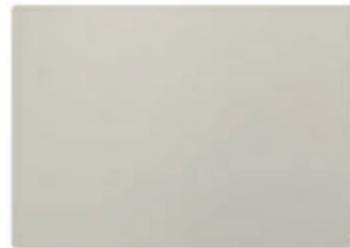

**Tovaglietta Skin - Verde salvia**

Placemat Skin, sage green  
 Nappe Skin, vert sauge  
 Mantel Skin, salvia  
 Klein Skin, salbeigrün

**Pelle riciclata - Recycled leather**

	cm	in
915 02 27 003	42x30	16,5 x 11,8



**Tovaglietta Skin - Terra**

Placemat Skin, earth brown  
 Nappe Skin, brun terre  
 Mantel Skin, marrón tierra  
 Klein Skin, erd-braun

**Pelle riciclata - Recycled leather**

	cm	in
915 02 27 004	42x30	16,5 x 11,8



**Tovaglietta Skin - Tortora**

Placemat Skin, taupe  
 Nappe Skin, individuelle taupe  
 Mantel Skin, individual gris topo  
 Klein Skin, tisch Tuch grau

**Pelle riciclata - Recycled leather**

	cm	in
915 02 27 006	42x30	16,5 x 11,8

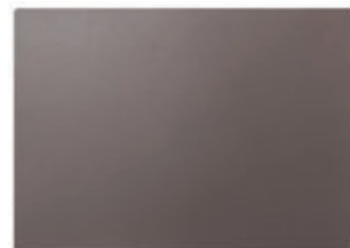

**Tovaglietta Skin - Nera**

Placemat Skin, black  
 Nappe Skin, noire  
 Mantel Skin, negro  
 Klein Skin, schwarz

**Pelle riciclata - Recycled leather**

	cm	in
915 02 27 001	42x30	16,5 x 11,8

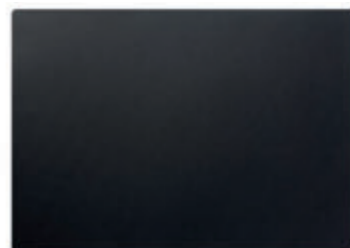

**Tovaglietta Skin - Blu**

Placemat Skin, blue navy  
 Nappe Skin, bleu marine  
 Mantel Skin, azul marino  
 Klein Skin, marineblau

**Pelle riciclata - Recycled leather**

	cm	in
915 02 27 002	42x30	16,5 x 11,8



**Tovaglietta Nuance - Crema**

Placemat Nuance, cream  
 Nappe Nuance, crème  
 Mantel Nuance, crema  
 Klein Nuance, cream

**Pvc - Pet**

	cm	in
915 03 27 005	42x30	16,5 x 11,8

**Tovaglietta Nuance - Cioccolato**

Placemat Nuance, chocolate  
 Nappe Nuance, chocolat  
 Mantel Nuance, chocolate  
 Klein Nuance, schokoladenbraun

**Pvc - Pet**

	cm	in
915 03 27 003	42x30	16,5 x 11,8

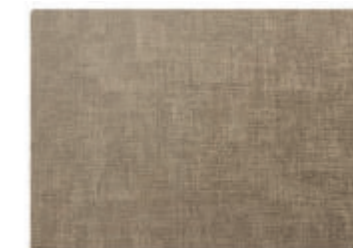
**Tovaglietta Nuance - Terra**

Placemat Nuance, earth brown  
 Nappe Nuance, brun terre  
 Mantel Nuance, marrón tierra  
 Klein Nuance, erd-braun

**Pvc - Pet**

	cm	in
915 03 27 004	42x30	16,5 x 11,8

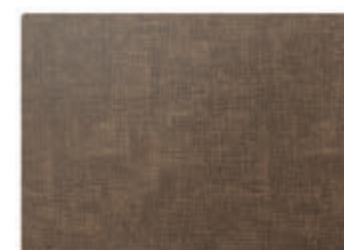
**Tovaglietta Nuance - Tortora**

Placemat Nuance, taupe  
 Nappe Nuance, individuelle taupe  
 Mantel Nuance, individual gris topo  
 Klein Nuance, tischtuch grau

**Pvc - Pet**

	cm	in
915 03 27 006	42x30	16,5 x 11,8

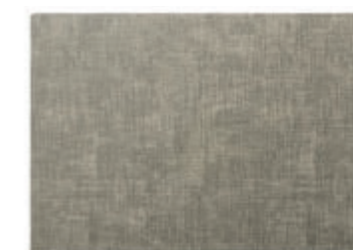
**Tovaglietta Nuance - Nero Carbone**

Placemat Nuance, charcoal  
 Nappe Nuance, noir charbon  
 Mantel Nuance, negro carbón  
 Klein Nuance, kohlschwarz

**Pvc - Pet**

	cm	in
915 03 27 001	42,5x30	16,73 x 11,81

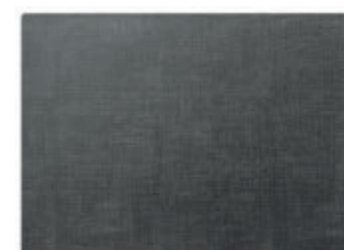
**Tovaglietta Nuance - Blu**

Placemat Nuance, blue navy  
 Nappe Nuance, bleu marine  
 Mantel Nuance, azul marino  
 Klein Nuance, marineblau

**Pvc - Pet**

	cm	in
915 03 27 002	42,5x30	16,73 x 11,81



**Secchio Champagne 3 bottiglie**

Champagne bucket for 3 bottles  
 Seau à champagne pour 3 bouteilles  
 Champagnerkühler für 3 Flaschen  
 Cubitera para champagne de 3 botellas

**Acciaio Inox 18/10 - St. Steel 18/10**

	ø cm	H. cm	ø in	H. in
V78 05 20 024	25	22,5	9,84	8,86



**Supporto secchio Champagne 3 bottiglie**

Stand for champagne bucket for 3 bottles  
 Support pour seau à champagne pour 3 bouteilles  
 Soporte para cubitera de champagne de 3 botellas  
 Ständer für Champagnerkühler für 3 Flaschen

**Acciaio Inox 18/10 - St. Steel 18/10**

	cm	in
V78 05 20 678	57	22,1/2

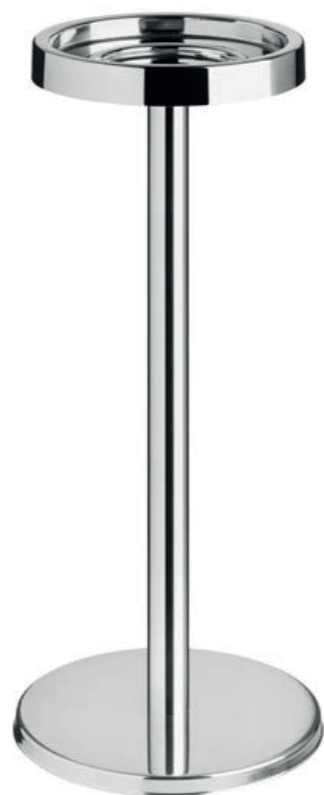



**Lampada ricaricabile Tempo ottonata**

Tempo rechargeable lamp, brushed brass  
 Lampe rechargeable Tempo, laiton brossé  
 Lampe, wiederaufladbar, Tempo, latón cepillado  
 Lámpara recargable Tempo, gebürstetes Messing

**Alluminio verniciato - Varnished Aluminum**

	ø cm	ø in	H. cm	H. in
910 85 17 001	10	3,7/8	28	11

**Supporto per cassette Life, 1 piano**

Life cassette holder, 1 shelves  
Support pour cassette Life, 1 étages  
Soporte para cassetes Life, 1 niveles  
Life Kassettenhalter, 1-stöckig

**Acciaio Verniciato Nero - Black Painted Steel**

	L cm	H. cm	P cm	L in	H. in	P in
V33 18 42 053	40	21	37	15,75	8,27	14,57

**Supporto per cassette Life, 1 piano**

Life cassette holder, 1 shelf  
Support pour cassette Life, 1 étages  
Soporte para cassetes Life, 1 niveles  
Life Kassettenhalter, 1-stöckig

**Acciaio Verniciato Nero - Black Painted Steel**

	L cm	H. cm	P cm	L in	H. in	P in
V33 18 42 052	55	21	37	21,65	8,27	14,57

**Supporto per cassette Life, 2 piani**

Life cassette holder, 2 shelves  
Support pour cassette Life, 2 étages  
Soporte para cassetes Life, 2 niveles  
Life Kassettenhalter, 2-stöckig

**Acciaio Verniciato Nero - Black Painted Steel**

	L cm	H. cm	P cm	L in	H. in	P in
V33 18 42 051	55	43	37	21,65	16,93	14,57

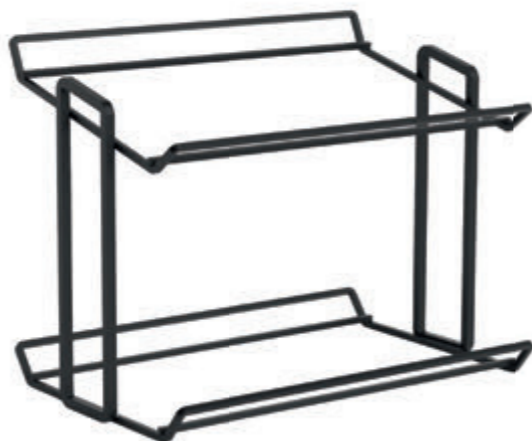
**Cassetta quadrata Life**

Crate, square, Life  
Cassette carrée Life  
Caja cuadrada Life  
Kiste, quadratisch Life

**Legno di Acacia - Acacia Wood**

	cm	H. cm
V33 04 24 001	35 × 35	5
V33 04 24 002	35 × 35	8

**Cassetta rettangolare Life**

Crate, rectangular, Life  
Cassette rectangulaire Life  
Caja rectangular Life  
Kiste, rechteckig Life

**Legno di Acacia - Acacia Wood**

	cm	H. cm
V33 04 24 003	52,5 × 35	5
V33 04 24 004	52,5 × 35	8



**abert**

[www.abert.it](http://www.abert.it)